

Ophthalmic Instruments

HIGHEST OPTICAL QUALITY AND THE MOST ACCURATE DIAGNOSIS

HEINE ophthalmic instruments set the industry standard for optical quality and diagnostic accuracy. The HEINE range includes a wide variety of high-quality ophthalmic instruments for all aspects of general and specialised examination of the eye: Direct and Indirect ophthalmoscopes, specialty ophthalmic instruments including retinoscopes, retinometers, hand-held slit lamps and ophthalmic examination lamps.

The HEINE Ophthalmoscopes benefit from numerous patents and registered trade marks. The main features: The aspherical optical system (AOS) in HEINE BETA® Direct Ophthalmoscopes, the ParaStop® feature in the HEINE Retinoscope and the simultaneous adjustment of convergence and parallax in HEINE OMEGA® Indirect Ophthalmoscopes.



HEINE Direct Ophthalmoscopes



Aspherical
Conventional



Red free filter for all apertures

Range

Number of Lenses (except „0“)

1 D Steps

Dustproof
Dust protected

Metal chassis

Professional
Compact

Battery 2.5V
Rechargeable battery 2.5V
Rechargeable battery 3.5V

Page

	BETA 200 S	BETA 200/BETA 200 M2 Opt. 1 Opt. 2	K 180 Opt. 1 Opt. 2	mini 3000
Optical System				
Aspherical	<input type="checkbox"/>	<input type="checkbox"/>	<input type="checkbox"/>	<input type="checkbox"/>
Conventional	<input type="checkbox"/>	<input type="checkbox"/>	<input type="checkbox"/>	<input type="checkbox"/>
Apertures				
Black dot	<input type="checkbox"/>	<input type="checkbox"/>	<input type="checkbox"/>	<input type="checkbox"/>
Black circle	<input type="checkbox"/>	<input type="checkbox"/>	<input type="checkbox"/>	<input type="checkbox"/>
Blue circle	<input type="checkbox"/>	<input type="checkbox"/>	<input type="checkbox"/>	<input type="checkbox"/>
Star	<input type="checkbox"/>	<input type="checkbox"/>	<input type="checkbox"/>	<input type="checkbox"/>
Sunburst	<input type="checkbox"/>	<input type="checkbox"/>	<input type="checkbox"/>	<input type="checkbox"/>
Vertical line	<input type="checkbox"/>	<input type="checkbox"/>	<input type="checkbox"/>	<input type="checkbox"/>
Semi-circle	<input type="checkbox"/>	<input type="checkbox"/>	<input type="checkbox"/>	<input type="checkbox"/>
Green circle	<input type="checkbox"/>	<input type="checkbox"/>	<input type="checkbox"/>	<input type="checkbox"/>
Red free filter for all apertures	<input type="checkbox"/>	<input type="checkbox"/>	<input type="checkbox"/>	<input type="checkbox"/>
Corrective lenses				
Range	- 36 to +38	- 35 to +40	- 35 to +40	- 20 to +20
Number of Lenses (except „0“)	74	27	27	18
1 D Steps	<input type="checkbox"/>	<input type="checkbox"/>	<input type="checkbox"/>	<input type="checkbox"/>
Dust protection				
Dustproof	<input type="checkbox"/>	<input type="checkbox"/>	<input type="checkbox"/>	<input type="checkbox"/>
Dust protected	<input type="checkbox"/>	<input type="checkbox"/>	<input type="checkbox"/>	<input type="checkbox"/>
Instrument size				
Professional	<input type="checkbox"/>	<input type="checkbox"/>	<input type="checkbox"/>	<input type="checkbox"/>
Compact	<input type="checkbox"/>	<input type="checkbox"/>	<input type="checkbox"/>	<input type="checkbox"/>
Available Power Sources				
Battery 2.5V	<input type="checkbox"/>	<input type="checkbox"/>	<input type="checkbox"/>	<input type="checkbox"/>
Rechargeable battery 2.5V	<input type="checkbox"/>	<input type="checkbox"/>	<input type="checkbox"/>	<input type="checkbox"/>
Rechargeable battery 3.5V	<input type="checkbox"/>	<input type="checkbox"/>	<input type="checkbox"/>	<input type="checkbox"/>
Page	041	042	045	047

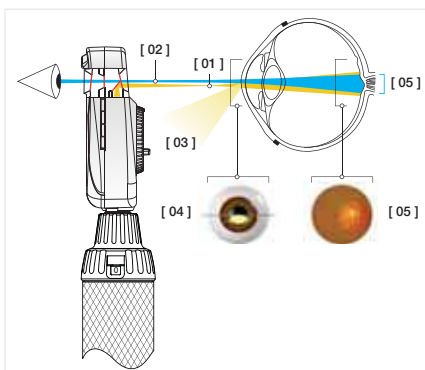

“Aspherical Optical System” (AOS) exclusively from HEINE

eliminates corneal and iris reflexes to provide large, crisp and glare-free fundus images.

[01] Flat, elliptical illumination beam produced by HEINE’s patented Aspherical Optical System.

[02] Observation path.

[03] Redirected iris and corneal reflexes.

[04] The elliptical light beam enters through the lower half of the cornea. The illumination beam has been separated from the observation beam (Gullstrand-Principle). All reflexes are diverted away from the observation beam due to the curvature of the reflective cornea. Due to the flat, compressed form of the light beam, a maximum amount of light enters through the pupil.

[05] Once past the anterior chamber, the light beam opens up dramatically to illuminate a large area of the retina.

HEINE BETA 200S® Ophthalmoscope

Superior aspherical optics and 74 single-diopter steps



∴ Eliminates corneal reflex

∴ Ideal for small pupils

∴ 74 single diopter steps

∴ Dustproof

- ∴ **Unique optical system.** HEINE optimizes the Gullstrand principle with aspherical optics (separation of illumination and observation beam). **Corneal and iris reflexes are eliminated.** A full view is guaranteed even with small pupils.
- ∴ **XHL Xenon Halogen Technology.** Bright, white light.
- ∴ **Range of lenses: 74 lenses from -36D to +38D.** Perfect focus even with high refractive errors.
 - + in 1 D steps: +1 through +38 D
 - in 1 D steps: -1 through -36 D
- ∴ **7 apertures with separate red-free filter.** Suitable for large or small pupils. Incorporates slit aperture, fixation star, cobalt blue filter and red-free filter for improved contrast.
- ∴ **Recessed, multi-coated viewing window.** Avoids stray light.
- ∴ **Dustproof housing.** Maintenance-free.
- ∴ **Optics mounted on precision metal chassis.** Durable, precise.
- ∴ **Ergonomic shape.** Instrument fits the orbita comfortably in any position.
- ∴ **Soft orbital support.** Protects the users' glasses and steadies the instrument.

BETA 200S Ophthalmoscope	2.5V	3.5V
without handle	C-001.30.120	C-002.30.120
XHL Xenon Halogen spare bulb	X-001.88.069	X-002.88.070

BETA 200S apertures:



Cobalt blue filter, fixation star with polar co-ordinates, large spot, small spot, pinhole, slit, hemispot



With red-free filter:

Cobalt blue filter, fixation star with polar coordinates, large spot, small spot, pinhole, slit, hemispot



HEINE BETA 200® Ophthalmoscope

The ophthalmoscope with superior aspherical optics



- Eliminates corneal reflex
- Ideal for small pupils
- Dustproof

The ophthalmoscope with unique aspherical optics and all the features of the BETA 200S, except for the macula aperture/pinhole and the following range of lenses: 27 lenses from -35D to +40D.

+ in 1 D steps:	1 – 10	15	20	40	D
- in 1 D steps:	1 – 10	15	20	25	35 D

BETA 200 Ophthalmoscope	2.5V	3.5V
without handle	C-001.30.100	C-002.30.100
BETA 200 M2 Ophthalmoscope, without handle. Like BETA 200, except with fixation star aperture without polar co-ordinates and with pinhole instead of small spot	C-001.30.102	C-002.30.102
XHL Xenon Halogen spare bulb	X-001.88.069	X-002.88.070

BETA 200 apertures

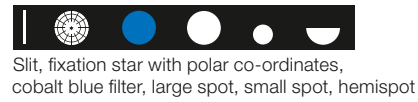

With red-free filter

BETA 200 M2 apertures



With red-free filter

For information on combined diagnostic sets, please see pages 163 – 165.

HEINE BETA 200S®/200® Ophthalmic Diagnostic Sets

Set complete with: **BETA 200S Ophthalmoscope**
1 spare bulb
hard case



BETA 200S Ophthalmoscope Sets	2.5V	3.5V (NiMH)	3.5V
BETA battery handle	C-261.10.118		
BETA R rechargeable handle for mains socket		C-261.20.376	C-261.27.376
BETA TR rechargeable handle with plug-in transformer		C-261.20.384	C-261.27.384
BETA NT rechargeable handle and NT 300 charger		C-261.20.420	
BETA L rechargeable handle and NT 300 charger			C-261.29.420

: Rechargeable handle with charge status display in the bottom insert.

HEINE BETA 200®/200 S® Ophthalmic Diagnostic Sets

Set complete with: **BETA 200 Ophthalmoscope**

1 spare bulb
hard case



BETA 200 Ophthalmoscope Sets	2.5V	3.5V (NiMH)	3.5V
BETA battery handle	C-144.10.118*		
BETA R rechargeable handle for mains socket		C-144.20.376	C-144.27.376
BETA TR rechargeable handle with plug-in transformer		C-144.20.384	C-144.27.384
BETA NT rechargeable handle and NT 300 charger		C-144.20.420	
BETA L rechargeable handle and NT 300 charger			C-144.29.420

*Available with large battery handle X-001.99.120 (doesn't fit into hard cases). Please specify with your order.

Set complete with: **BETA 200S Ophthalmoscope, BETA 200 Streak Retinoscope**

1 spare bulb for each instrument
hard case



BETA 200S Ophthalmoscope Sets	2.5V	3.5V (NiMH)	3.5V
BETA battery handle	C-262.10.118		
BETA R rechargeable handle for mains socket		C-262.20.376	C-262.27.376
BETA TR rechargeable handle with plug-in transformer		C-262.20.384	C-262.27.384
BETA NT rechargeable handle and NT 300 charger		C-262.20.420	
BETA L rechargeable handle and NT 300 charger			C-262.29.420

Set complete with: **BETA 200 Ophthalmoscope, BETA 200 Streak Retinoscope**

1 spare bulb for each instrument
hard case



BETA 200 Ophthalmoscope Sets	2.5V	3.5V (NiMH)	3.5V
BETA battery handle	C-145.10.118*		
BETA R rechargeable handle for mains socket		C-145.20.376	C-145.27.376
BETA TR rechargeable handle with plug-in transformer		C-145.20.384	C-145.27.384
BETA NT rechargeable handle and NT 300 charger		C-145.20.420	
BETA L rechargeable handle and NT 300 charger			C-145.29.420

*Available with large battery handle X-001.99.120 (doesn't fit into hard cases). Please specify with your order.

: Rechargeable handle with charge status display in the bottom insert.

HEINE Diagnostic Sets

Set complete: **BETA 200 Ophthalmoscope, BETA 200 F.O. Otoscope**



1 set of reusable tips (B-000.11.111)

5 of both AllSpec disposable tips 2.5 and 4 mm dia. (B-000.11.119)

one spare bulb each



hard case



Diagnostic Sets	2.5V	3.5V (NiMH)	3.5V 
BETA battery handle	A-132.10.118		
BETA R rechargeable handle for mains socket		A-132.20.376	A-132.27.376
BETA TR rechargeable handle with plug-in transformer		A-132.20.384	A-132.27.384
BETA NT rechargeable handle and NT 300 charger		A-132.20.420	
 BETA L rechargeable handle and NT 300 charger			A-132.29.420

As set above, but with additional multi-purpose illuminator.



Diagnostic Sets	2.5V	3.5V (NiMH)	3.5V 
BETA battery handle	A-134.10.118		
BETA R rechargeable handle for mains socket		A-134.20.376	A-134.27.376
BETA TR rechargeable handle with plug-in transformer		A-134.20.384	A-134.27.384
BETA NT rechargeable handle and NT 300 charger		A-134.20.420	
 BETA L rechargeable handle and NT 300 charger			A-134.29.420

Set complete: **BETA 200 Ophthalmoscope, BETA 100 Diagnostic Otoscope**



1 set of reusable specula (B-000.11.221)

10 UniSpec disposable tips 4 mm dia. (B-000.11.237)

one spare bulb each

hard case



Diagnostic Sets	2.5V	3.5V (NiMH)	3.5V 
BETA battery handle	A-234.10.118		
BETA R rechargeable handle for mains socket		A-234.20.376	A-234.27.376
BETA TR rechargeable handle with plug-in transformer		A-234.20.384	A-234.27.384
BETA NT rechargeable handle and NT 300 charger		A-234.20.420	
 BETA L rechargeable handle and NT 300 charger			A-234.29.420

: Rechargeable handle with charge status display in the bottom insert.

HEINE K 180® Ophthalmoscope

Standard direct ophthalmoscope



∴ Reduces corneal reflex

∴ Dust-resistant

A full-featured instrument at an economical price.

- ∴ **Precision spherical HEINE optics.** Corneal and iris reflexes are eliminated.
- ∴ **XHL Xenon Halogen Technology.** Bright, white light. Clear retinal image.
- ∴ **Range of lenses: 27 lenses from -35D to +40D.** Brilliant image even at high corrections.

+ in 1 D steps:	1 – 10	15	20	40	D
- in 1 D steps:	1 – 10	15	20	25	35 D

- ∴ **Ergonomical shape.** The instrument fits the orbita comfortably.
- ∴ **Soft orbital rest.** Steadies the instrument and protects your glasses.
- ∴ **Choice of 5 apertures.** For both large and small pupils. Choice of fixation star or cobalt blue filter for corneal examination.
- ∴ **Dust-resistant housing.** Maintenance-free.
- ∴ **High-impact polycarbonate housing for durability.**

K 180 Ophthalmoscope	2,5V	3,5V
with aperture wheel 1, without handle	C-001.30.206	C-002.30.206
with aperture wheel 2, with cobalt blue filter, without handle	C-001.30.207	C-002.30.207
XHL Xenon Halogen spare bulb	X-001.88.084	X-002.88.086

K 180 apertures



Aperture wheel 1:
Slit, red-free filter, fixation star with polar co-ordinates, large spot, small spot



Aperture wheel 2:
Slit, red-free filter, cobalt blue filter, large spot, small spot

HEINE K 180® Ophthalmic Diagnostic Sets

Set complete with: **K 180 Ophthalmoscope**, in standard version with aperture wheel 1 soft pouch





K 180 Ophthalmoscope Sets	2.5V	3.5V (NiMH)	3.5V
BETA battery handle	C-182.10.118		
BETA R rechargeable handle for mains socket		C-182.20.376	C-182.27.376
BETA TR rechargeable handle with plug-in transformer		C-182.20.384	C-182.27.384
BETA NT rechargeable handle and NT 300 charger		C-182.20.420	
BETA L rechargeable handle and NT 300 charger			C-182.29.420

: Rechargeable handle with charge status display in the bottom insert.

HEINE K 180® Diagnostic Sets

Set complete with: **K180 Ophthalmoscope**, in standard version with aperture wheel
K 180 Otoscope
 1 set of reusable tips (B-000.11.111)
 hard case



K180 Diagnostic Sets	2.5V	3.5V (NiMH)	3.5V 
BETA battery handle	A-279.10.118		
BETA R rechargeable handle for mains socket		A-279.20.376	A-279.27.376
BETA TR rechargeable handle with plug-in transformer		A-279.20.384	A-279.27.384
BETA NT rechargeable handle and NT 300 charger		A-279.20.420	
 BETA L rechargeable handle and NT 300 charger			A-279.29.420

: Rechargeable handle with charge status display in the bottom insert.

HEINE mini 3000® Ophthalmoscope

Compact Pocket Ophthalmoscope



Top quality ophthalmoscope with fixation star aperture in pocket format. Quality optics in mini-format. Ideal for rounds and house calls. Can only be used with the mini 3000 handle system. Available in black or blue.

- ∴ **Enhanced XHL Xenon Halogen Technology.** Concentrated white light for perfect illumination and a brilliant image.
- ∴ **5 different apertures.** A full-function instrument incl. fixation star.
- ∴ **Range of lenses: 18 lenses from -20 D to +20 D.**

+	1	2	3	4	6	8	10	15	20 D
-	1	2	3	4	6	8	10	15	20 D

- ∴ **2-piece handle and head.** Easy to maintain, flexible.
- ∴ **High-quality handle: Chrome-finish upper section/refined plastic.** Shockproof, sturdy, non-slip.
- ∴ **Attachment clip with integrated on/off switch.** Secure. Switches off automatically when replaced in the pocket. 20.000 switch cycles guaranteed.
- ∴ **Replaceable batteries.** Size AA, or optional rechargeable battery with mini NT charger*.

∴ Modern pocket instrument

∴ Dust-resistant

∴ Switches off automatically

∴ Optional rechargeable handle

mini 3000 Ophthalmoscope	2.5V
with mini3000 Battery Handle, with batteries	D-001.71.120
without handle	D-001.71.105

XHL Xenon Halogen spare bulb	X-001.88.106
------------------------------	---------------------

mini 3000 apertures



Large spot, small spot, fixation star, hemispace, red-free filter

HEINE mini 3000® Diagnostic Sets



Set complete with: **mini 3000 Ophthalmoscope**
hard case

mini 3000 Diagnostic Sets	2.5V
mini 3000 battery handle with batteries	D-852.10.021



*To upgrade to a rechargeable instrument with mini NT charger, please see page 148.



HEINE mini 3000® Diagnostic Sets



All handles are fitted with batteries (IEC LR 6 AA size, or optional rechargeable battery with mini NT charger*). Please order spare bulbs separately.

Set complete with: **mini 3000 Ophthalmoscope, mini 3000 F.O. Otoscope**

1 set = 4 reusable tips (B-000.11.111)

5 of both 2.5 and 4 mm dia. AllSpec disposable tips (B-000.11.119)
hard case

mini 3000 Diagnostic Sets	2.5V
with 2 mini 3000 battery handles with batteries	D-873.11.021
as above but with mini 3000 Otoscope instead of mini 3000 F.O. Otoscope	D-873.21.021



*To upgrade to a rechargeable instrument with mini NT charger, please see page 148.

HEINE mini 3000® pocket instruments – a complete range of quality diagnostic instruments for your pocket. Available in black or blue. Please specify the colour you prefer when ordering. If not otherwise specified, we will supply black instruments.

A company makes history and gives a name to outstanding product quality: HEINE.

Founded in 1946, family owned, rich in tradition and today international market leader in a complete range of diagnostic instruments. HEINE products meet all international standards (ISO/CE) and represent the leading edge in precision and ergonomic design. Ongoing dedication to research and development has created a solid and diverse technology base for continued quality and product leadership. Over 500 employees worldwide contribute to this success.

www.heine.com

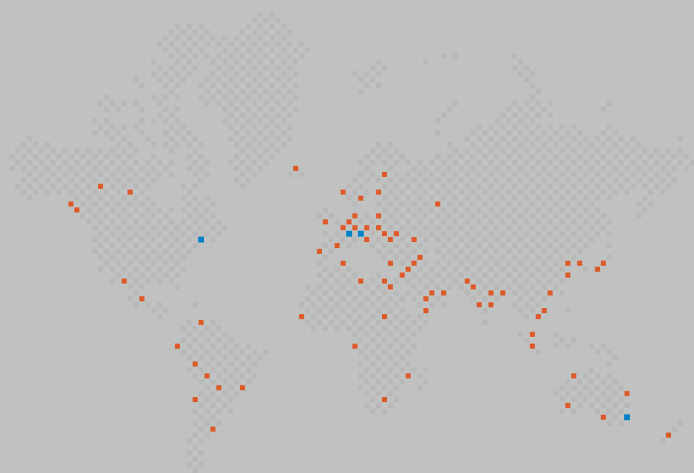

■ HEINE SUBSIDIARY COMPANIES
■ HEINE REPRESENTATIVES

GERMANY

HEINE Optotechnik GmbH & Co. KG
82211 Herrsching
Kientalstr. 7
Tel. +49 (0) 81 52-38 0
Fax +49 (0) 81 52-3 82 02
E-Mail: info@heine.com

NORTH AMERICA

HEINE USA LTD.
10 Innovation Way
Dover, NH 03820
Tel. (603) 7 42-71 03
Fax (603) 7 42-72 17
Toll Free (800) 367-4872
E-Mail: service@heine-na.com

AUSTRALIA

HEINE AUSTRALIA PTY. LTD.
Unit 9, 98 Old Pittwater Road
P.O. Box 717 Brookvale 2100
New South Wales
Tel. +61 (0) 2-99 38 95 00
Fax +61 (0) 2-99 39 23 05
E-Mail: info@heine.com.au

SWITZERLAND

HEINE (Schweiz) AG
Tobelackerstr. 9
CH-8212 Neuhausen am Rheinfall
Tel. +41 (0) 52-6 72 22 66
Fax +41 (0) 52-6 72 63 77
E-Mail: heine-schweiz@schaffhausen.ch

Your distributor

10/11. A-000.00.100 e

